

x23

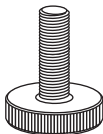

x25



x6

Ø 15 x 16



x23



x23

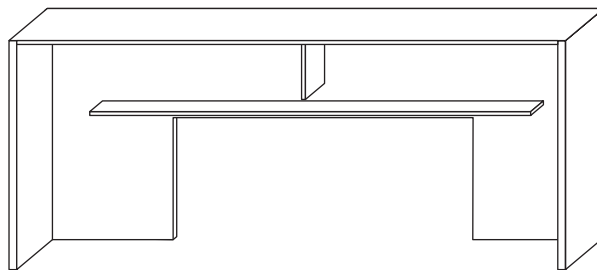
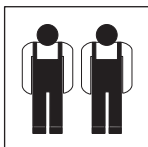
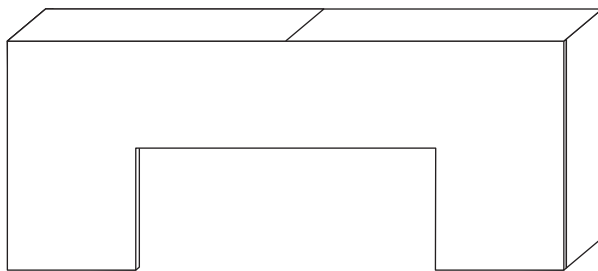

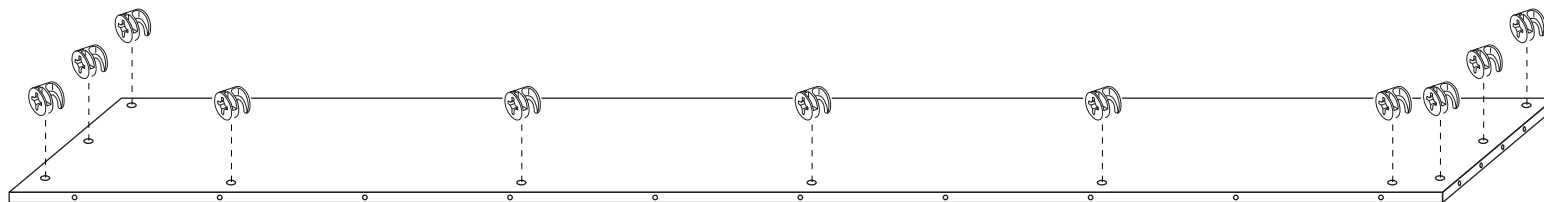
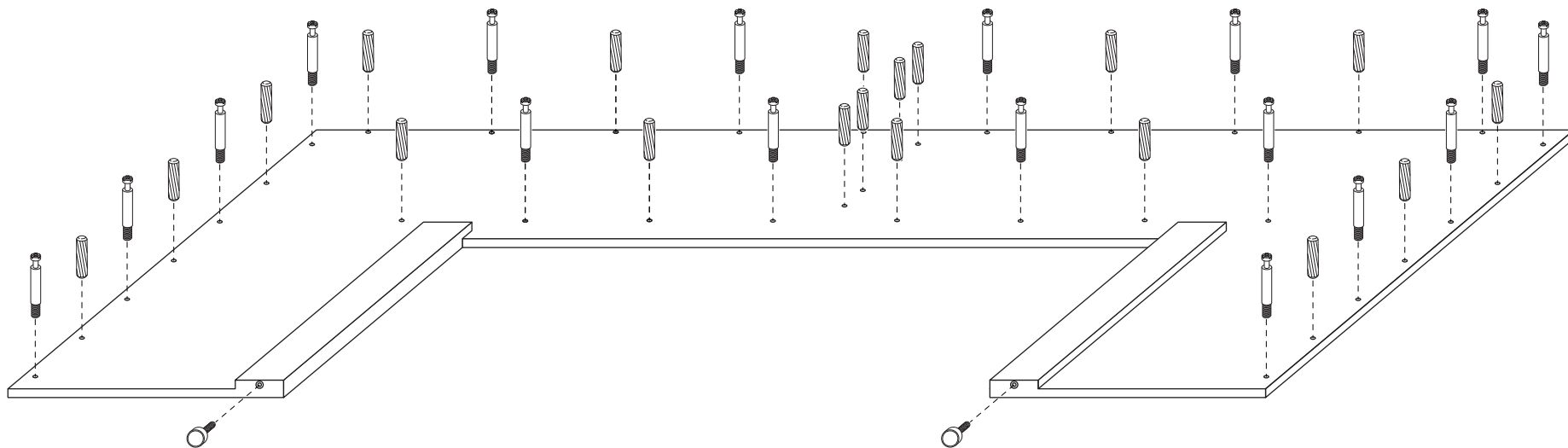

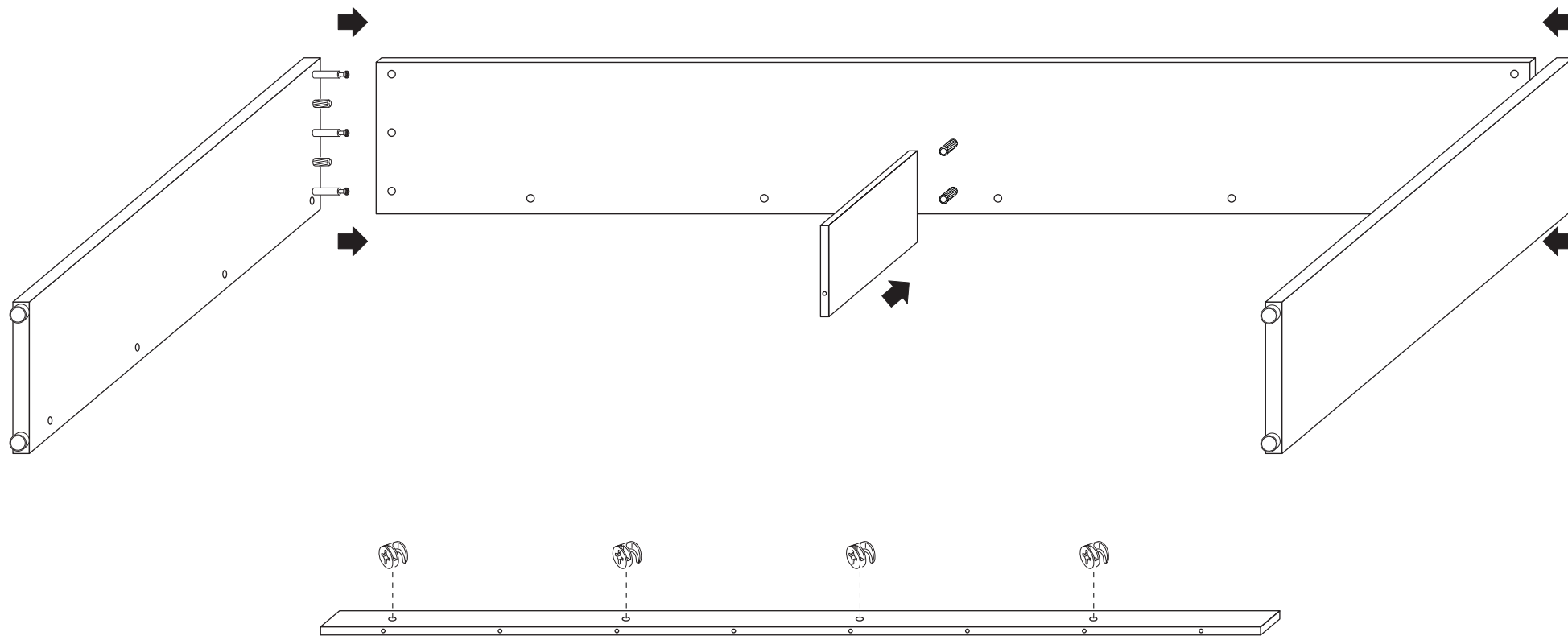

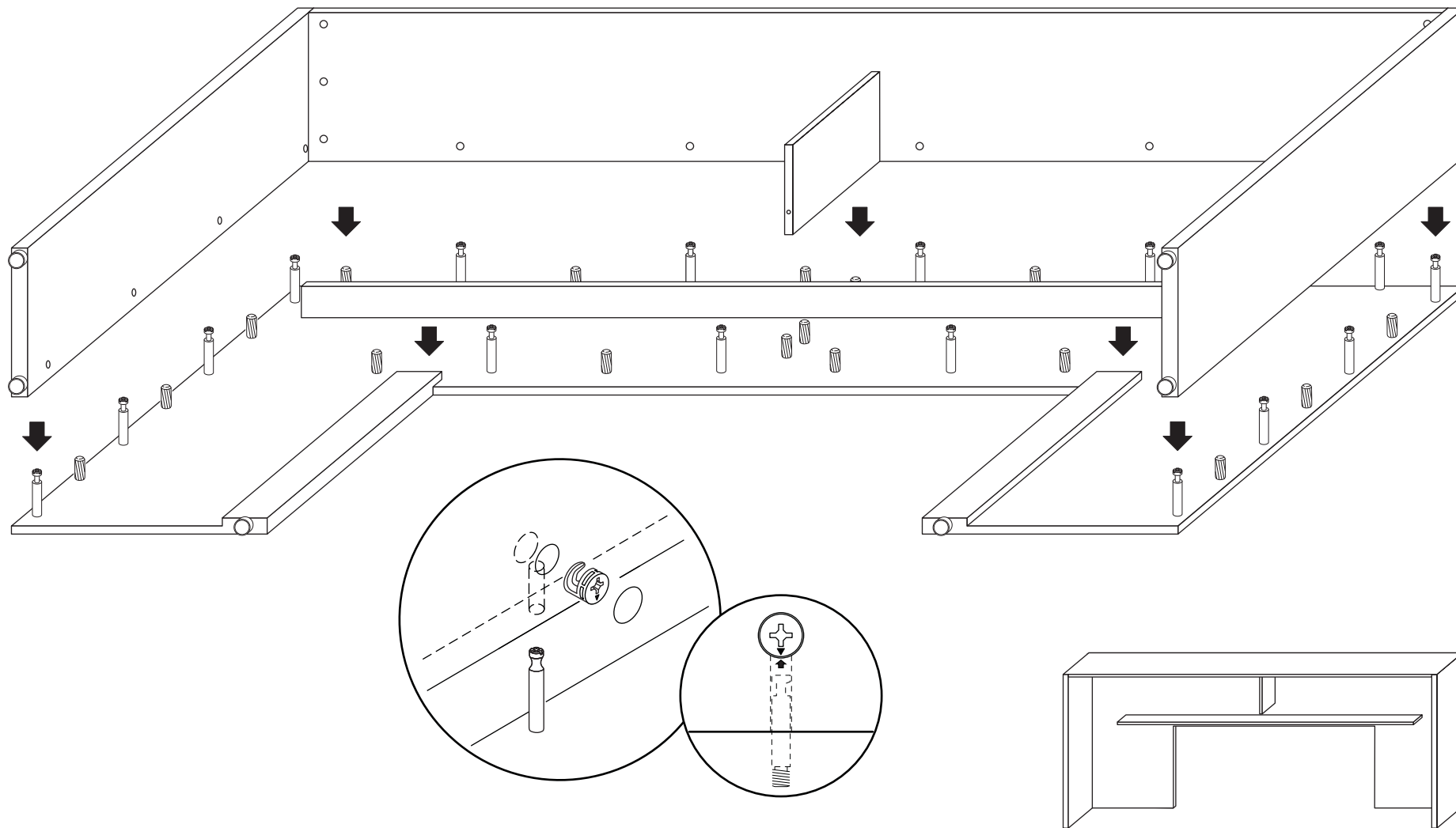

BK-1

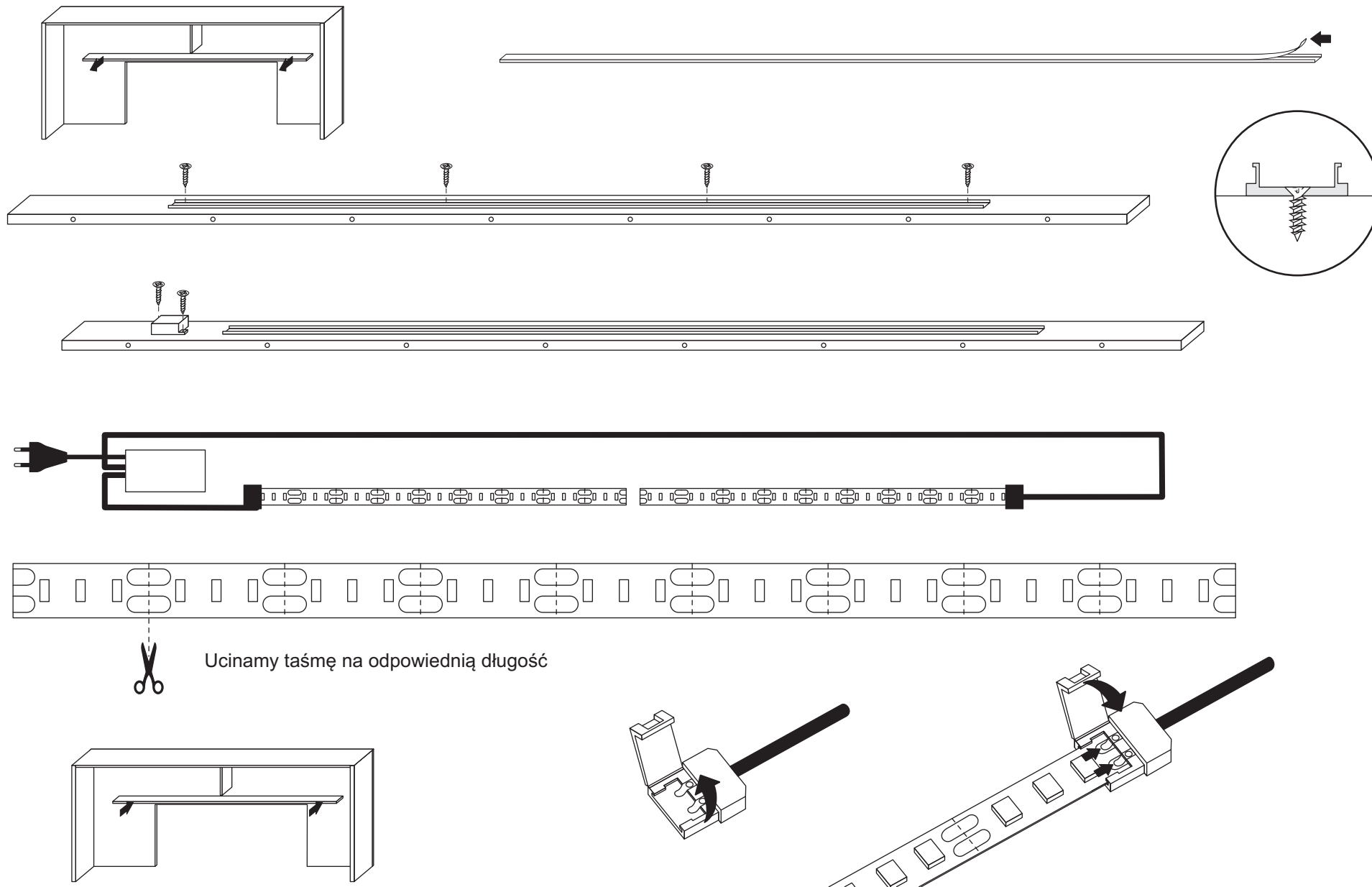

Ucinamy taśmę na odpowiednią długość

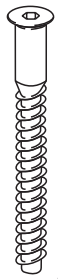
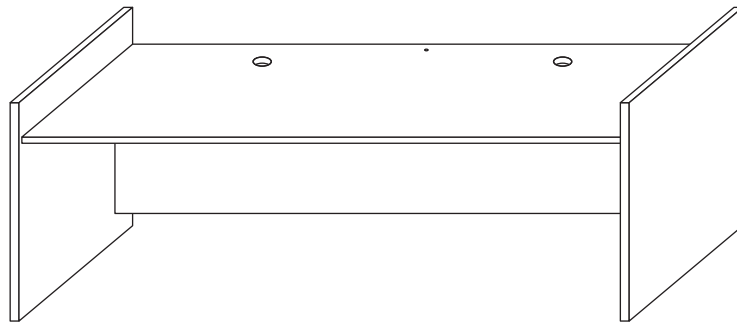

x5

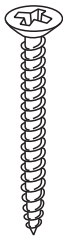

x4



x34



x26

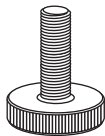

x4

Ø 15 x 23

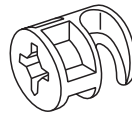

x18

Ø 15 x 16



x16



x34

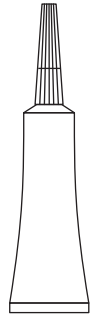

x1

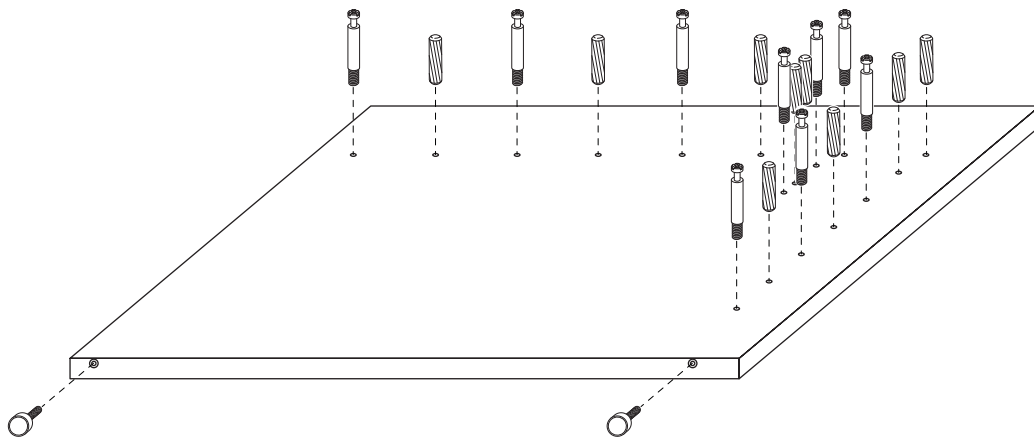
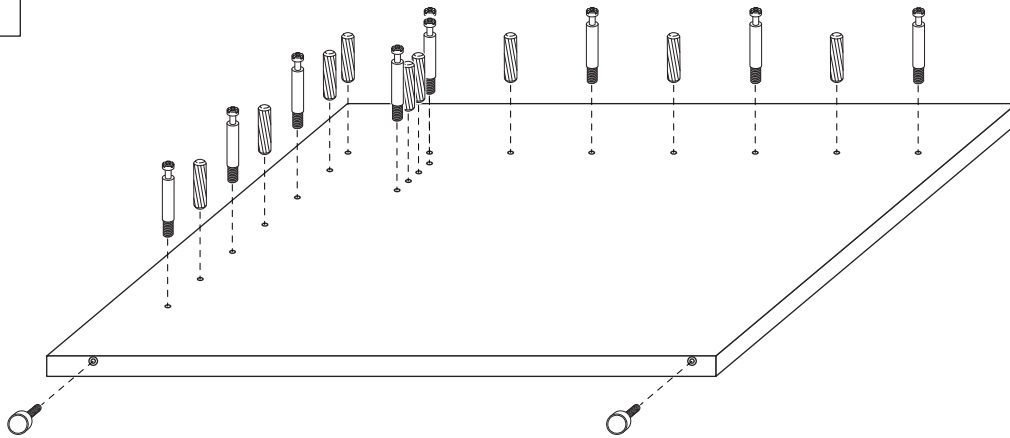
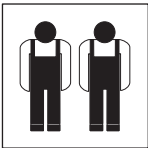

BK-1

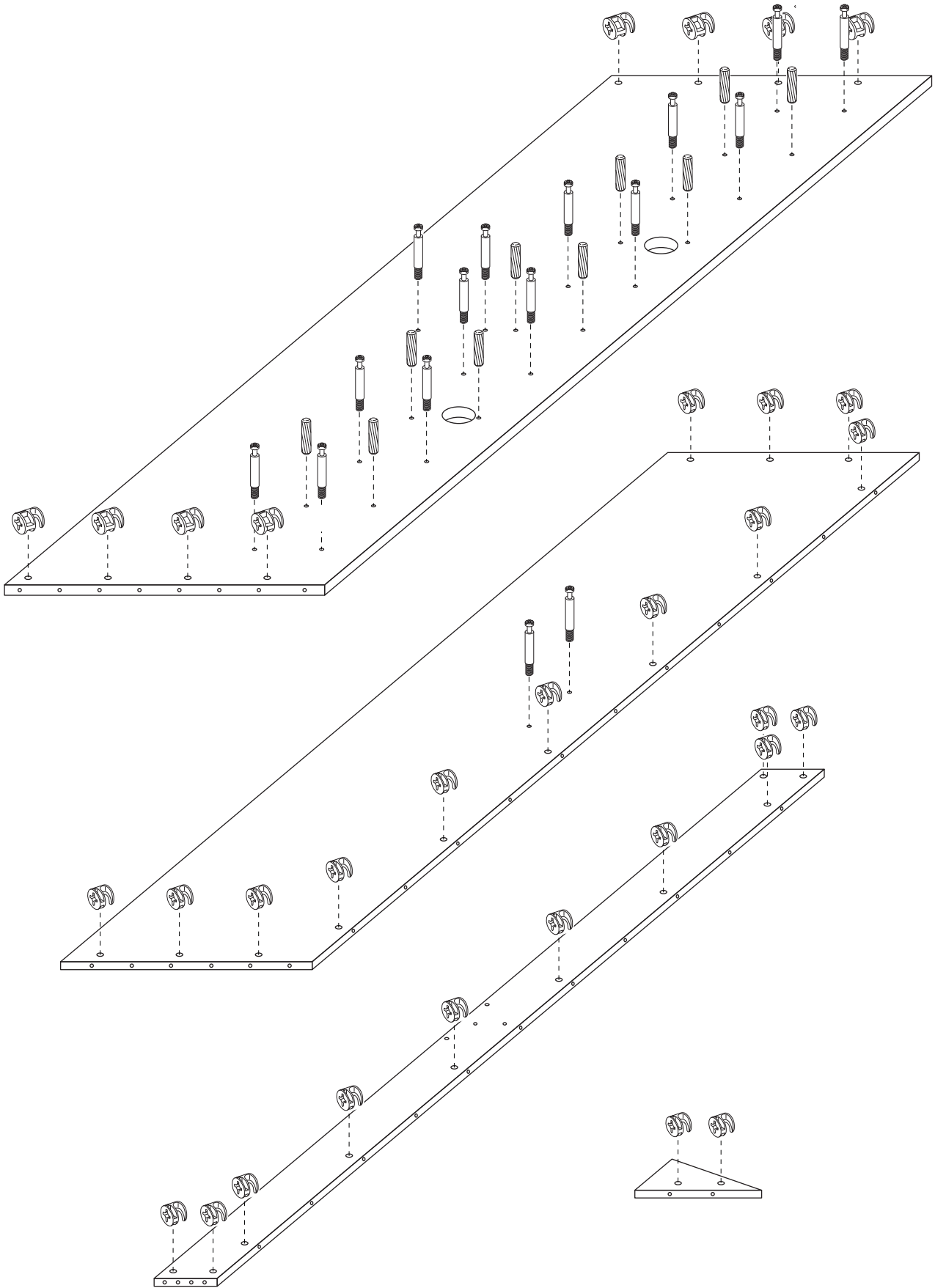

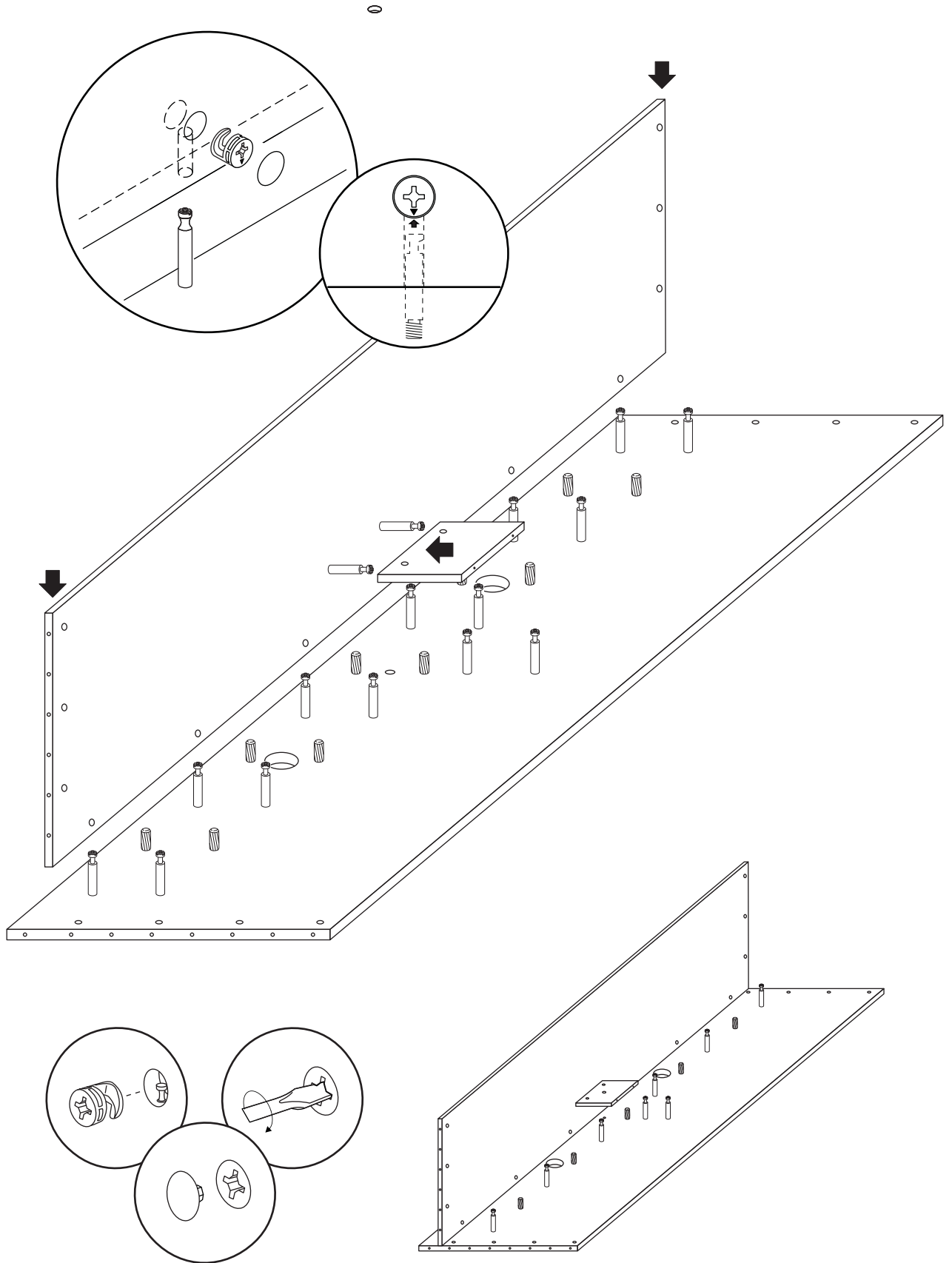

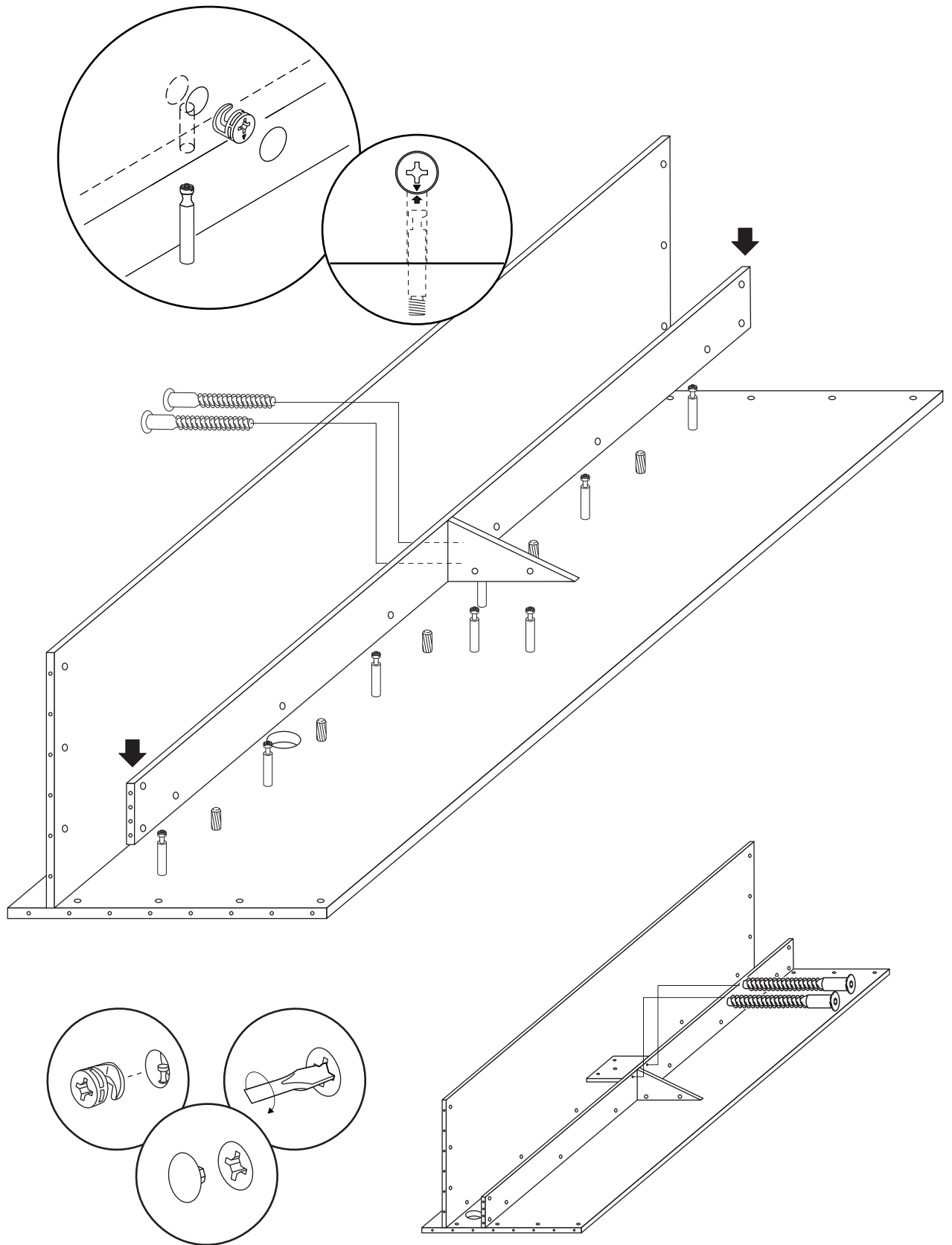

BK-1

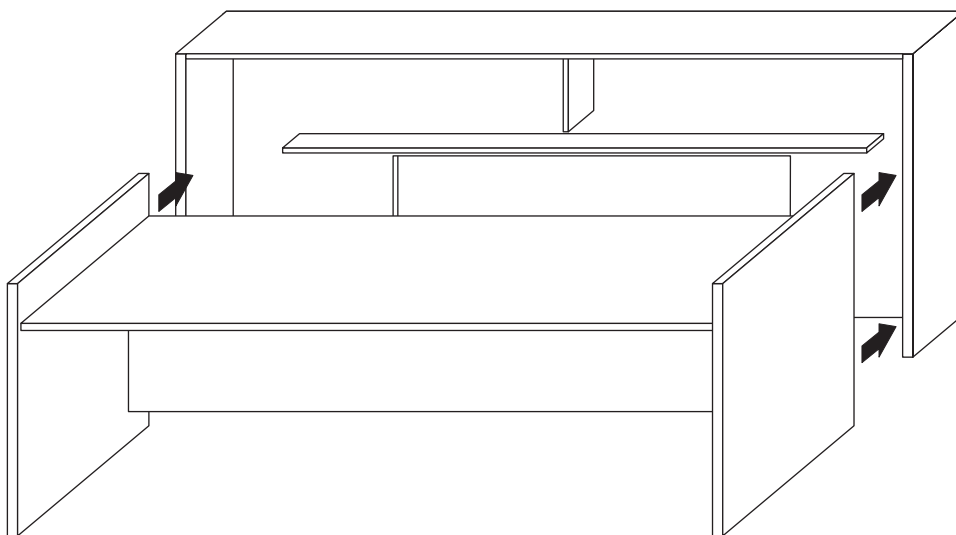
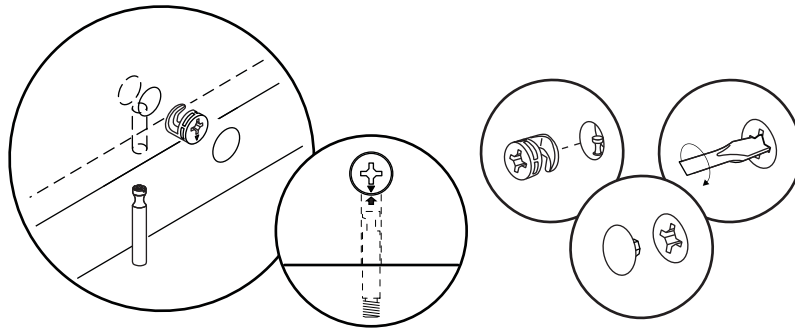
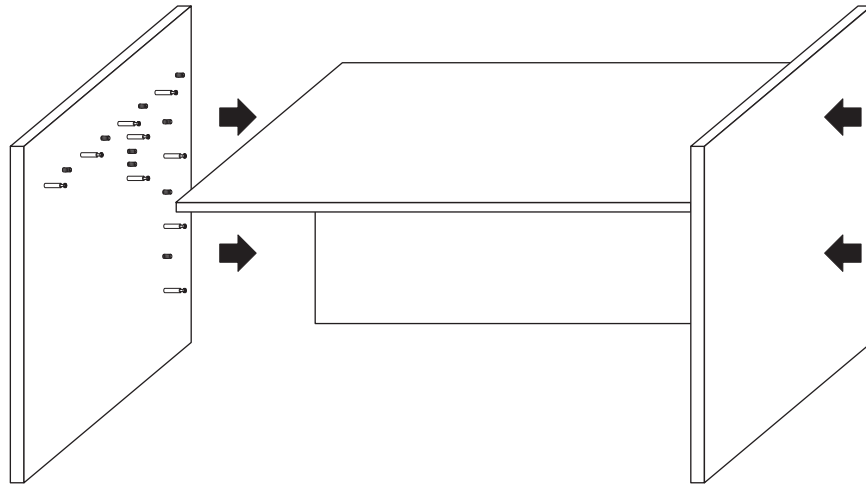

BK-1

