

Surinkimo schema
 Схема сборки
 Assembling scheme

Reikalingi įrankiai:



Инструменты для сборки:

Requiring tools:

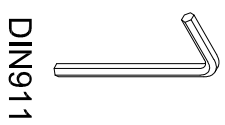

DIN911

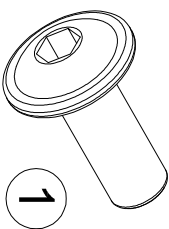

x20

1

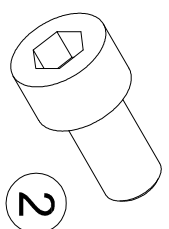

x10

2

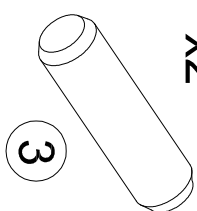

x2

3

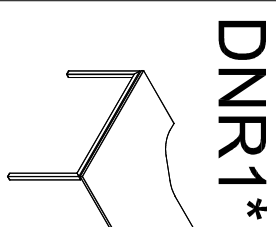

U

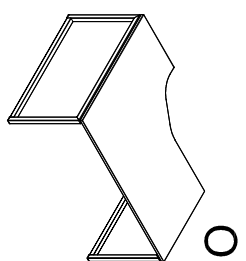

O

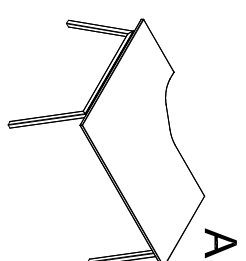

A

I

A

B

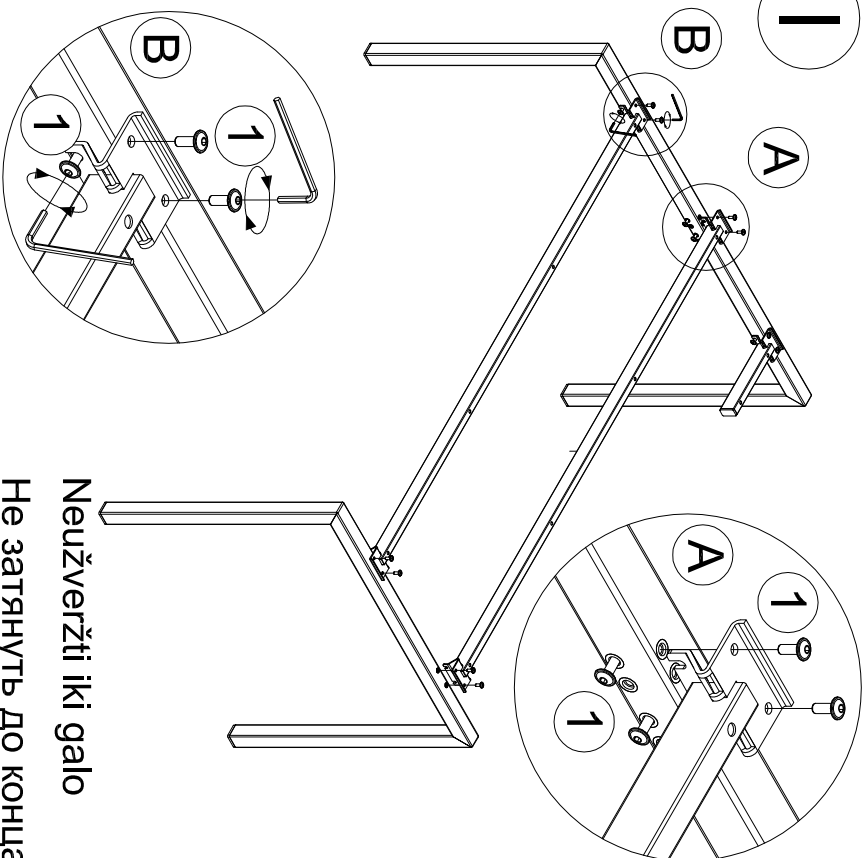

Neužveržti iki galo
 Не затянуть до конца
 Don't tighten to end

II

C

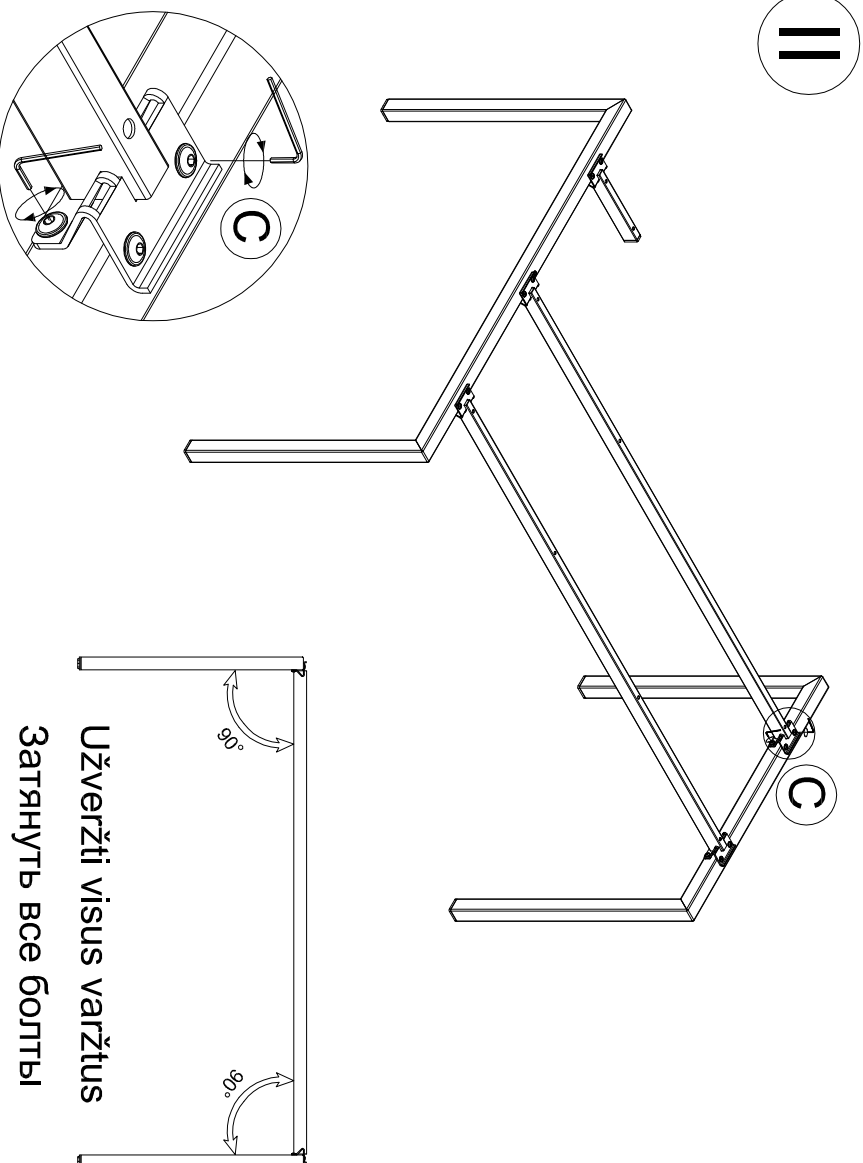

Užveržti visus varžtus
 Затянуть все болты
 Tighten up all screws

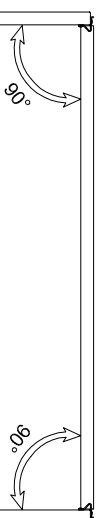

III

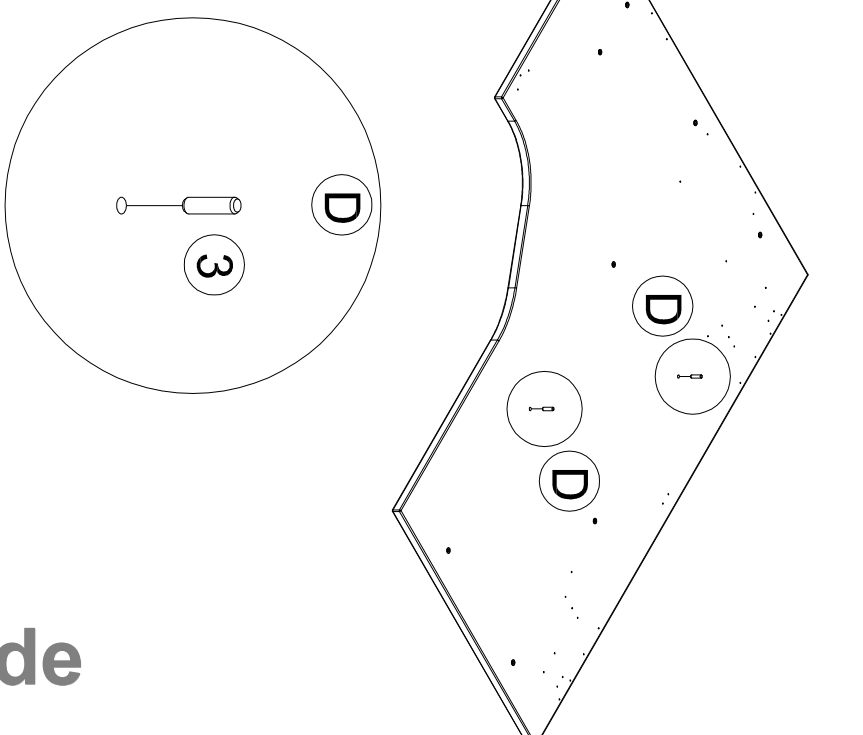

IV

E

F

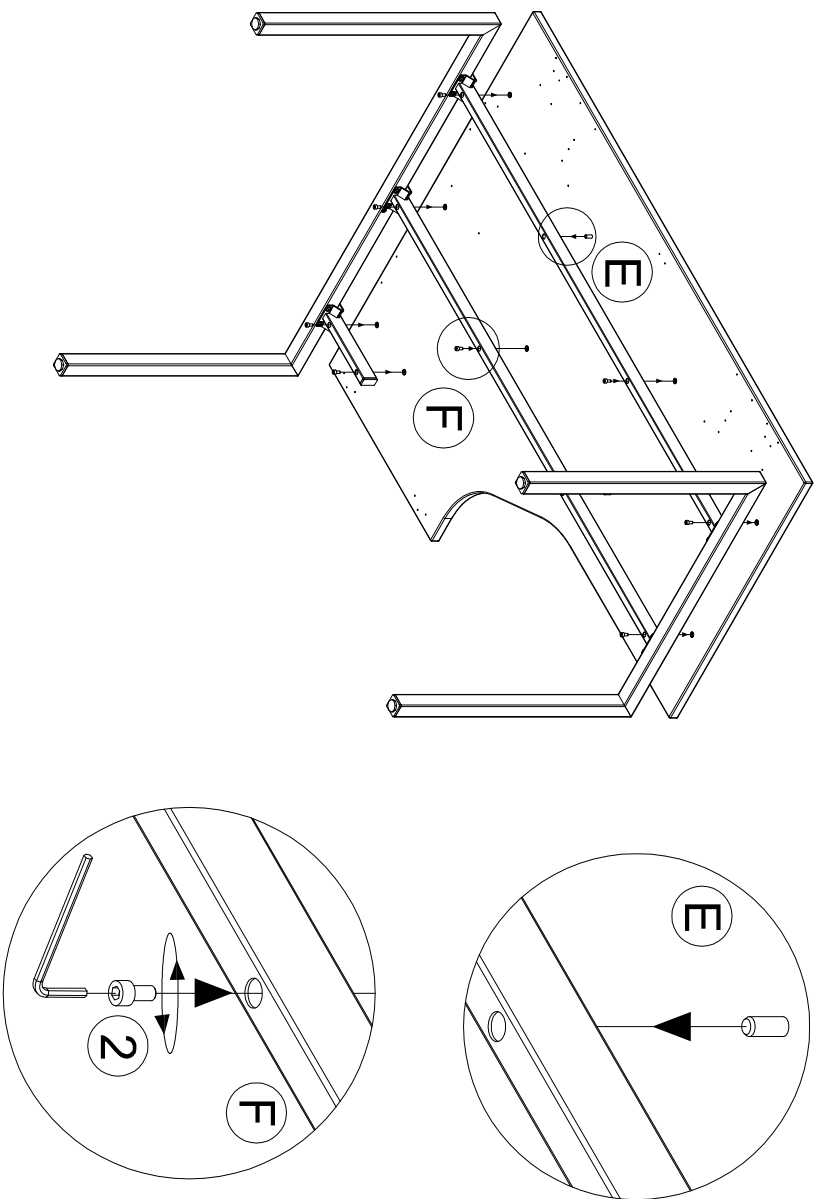

V

G

