

M60EB003

1/1

Surinkimo schema

Схема сборки

Assembling scheme

Reikalingi įrankiai:

Инструменты для сборки:

Requiring tools:

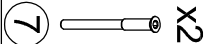
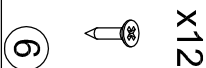
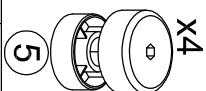
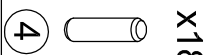
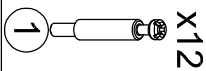
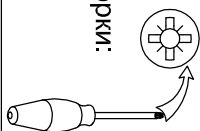

I

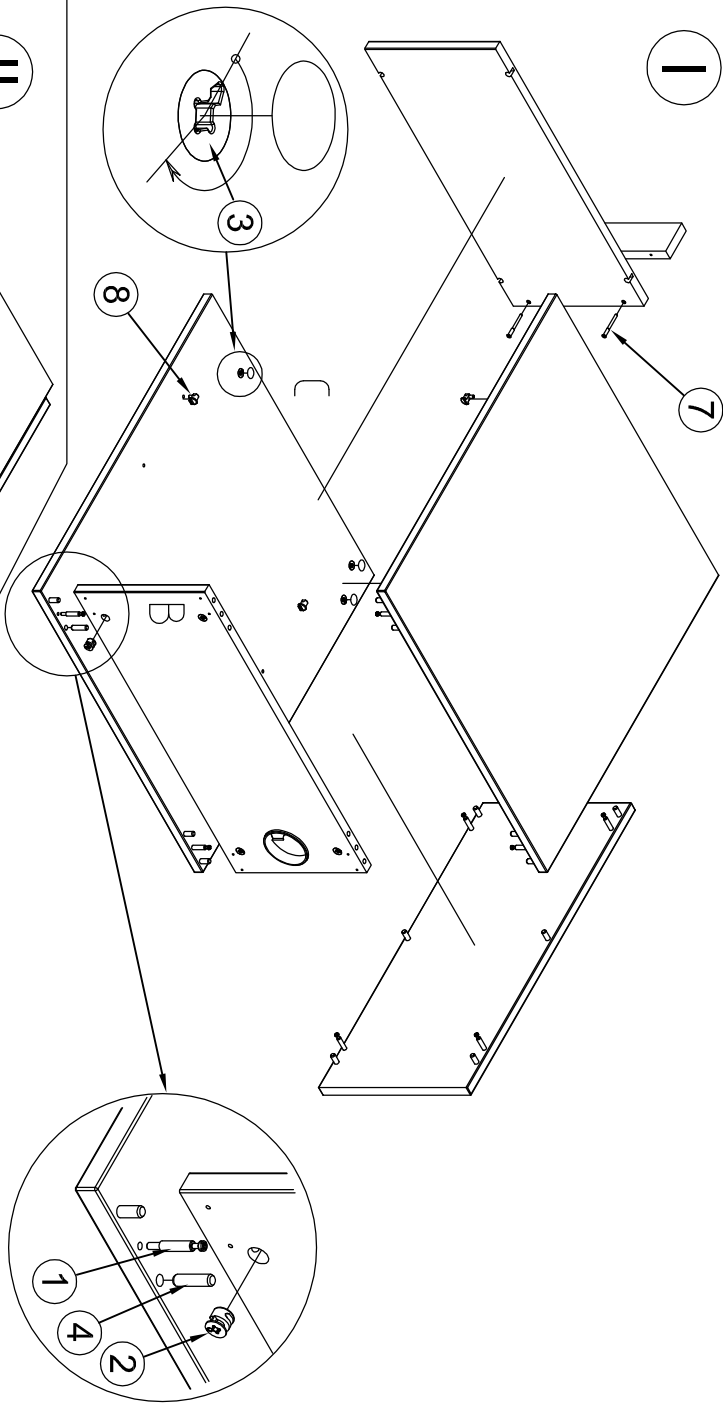

II

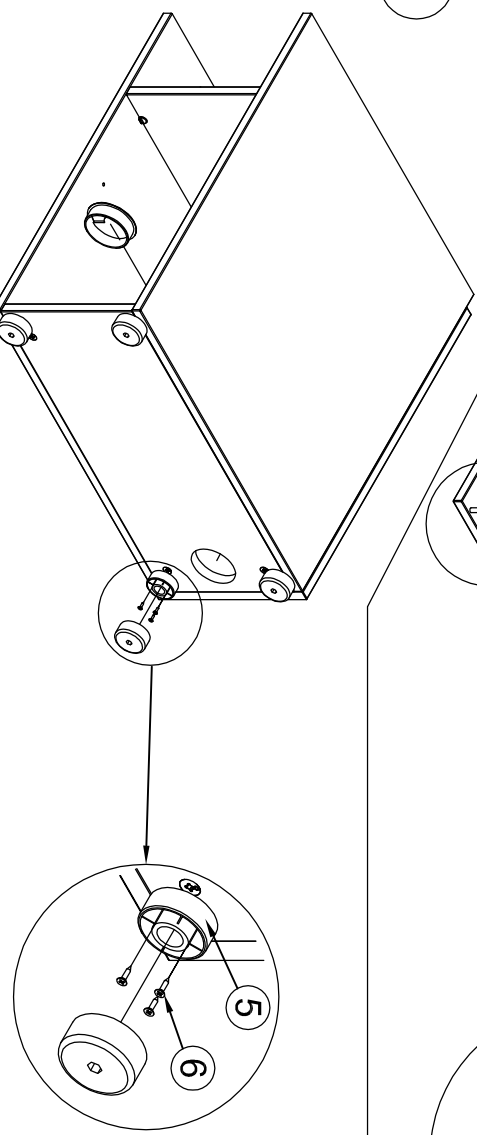



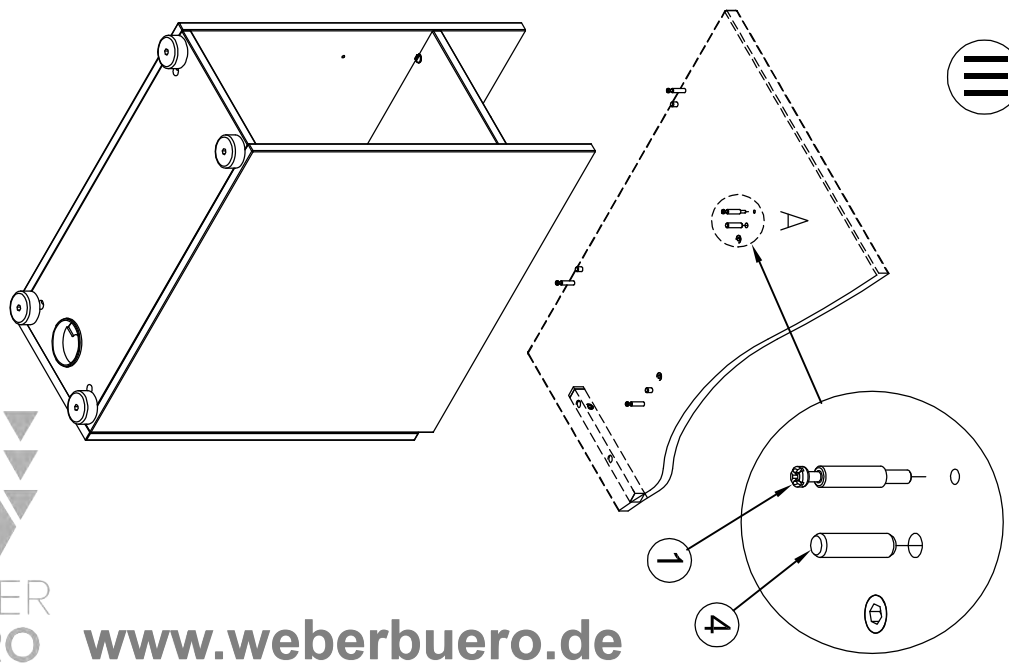



III



M60EB009

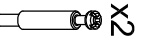



1/1

Surinkimo schema
Схема сборки
Assembling scheme

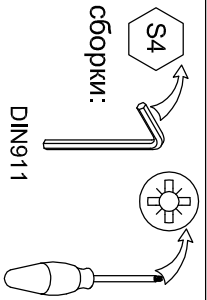
- x2  6
- x6  1
- x2  2
- x2  3
- x2  4
- x4  5

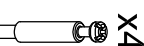
Reikalingi įrankiai:
Инструменты для сборки:
Requiring tools:



- x6  1
- x4  2
- x4  3
- x4  4
- x4  5

DIS163
DIS181

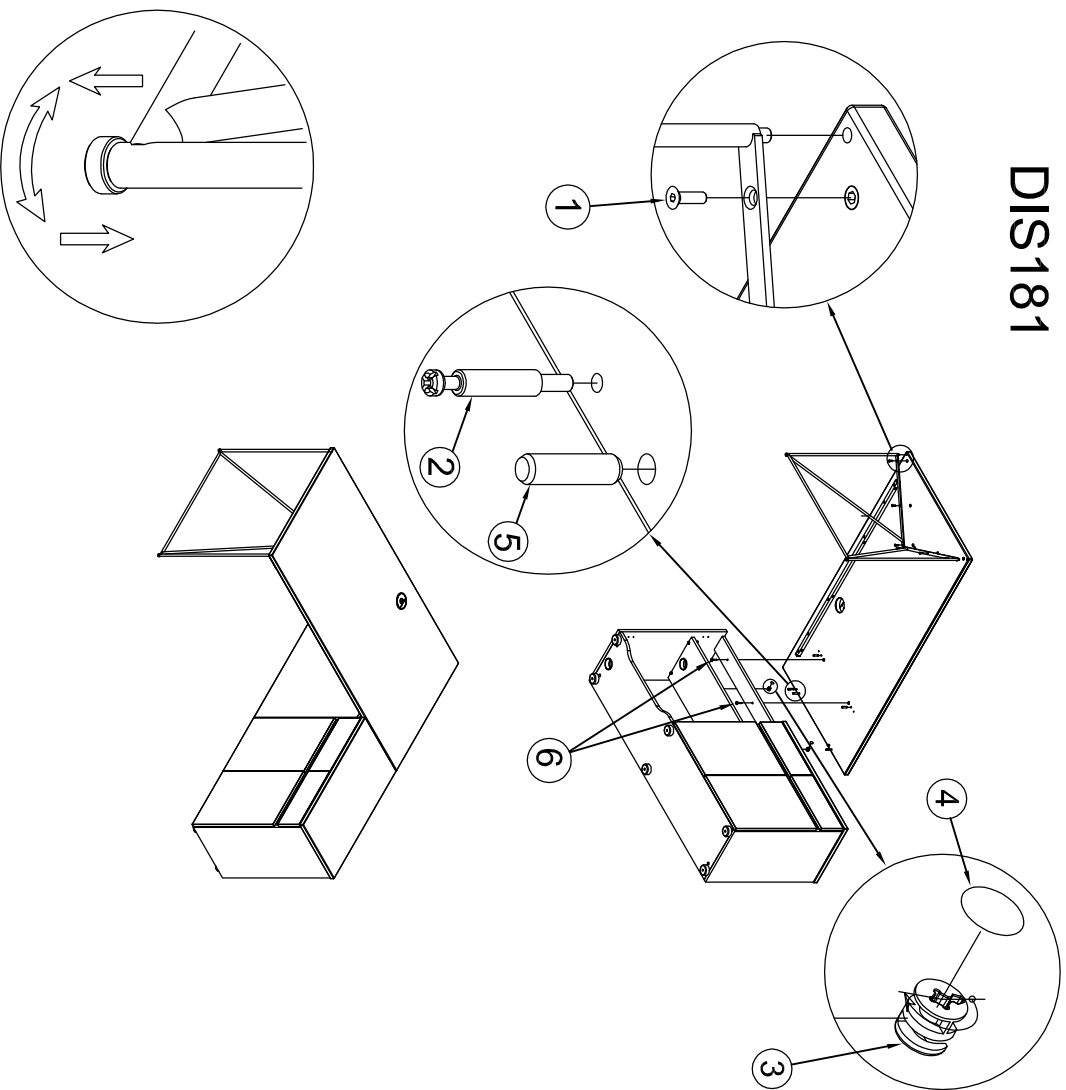

DIA161
DIA181

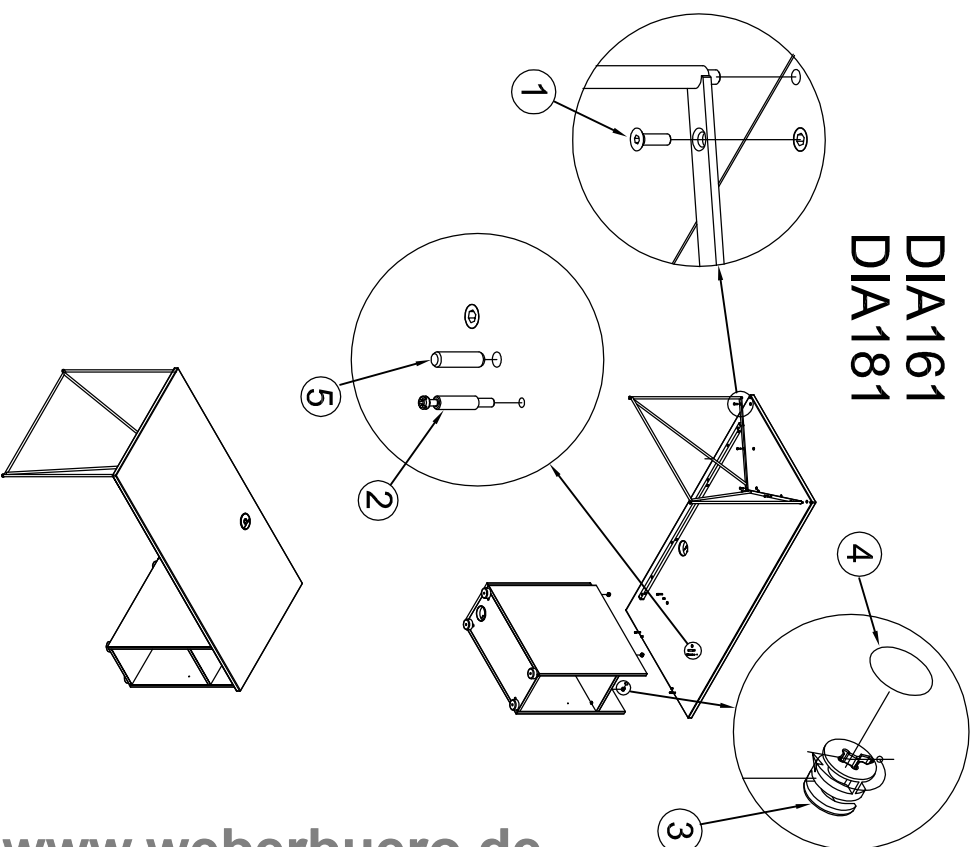

M60EB003

1/1

Surinkimo schema

Схема сборки







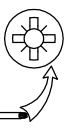

Assembling scheme

Reikalingi įrankiai:

Инструменты для сборки:

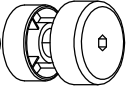
Requiring tools:



- X12  1
- X12  2
- X8  3
- X18  4
- X4  5
- X12  6
- X2  7
- X4  8

I

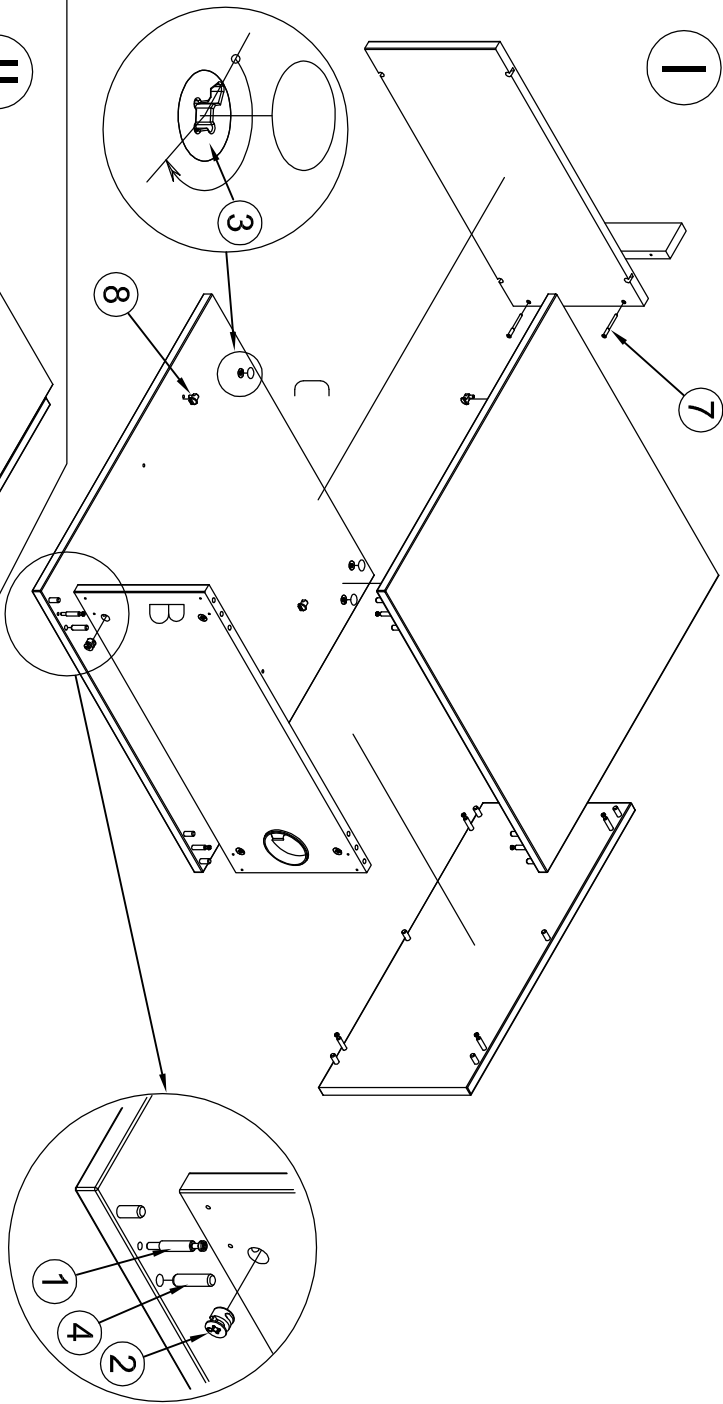

II

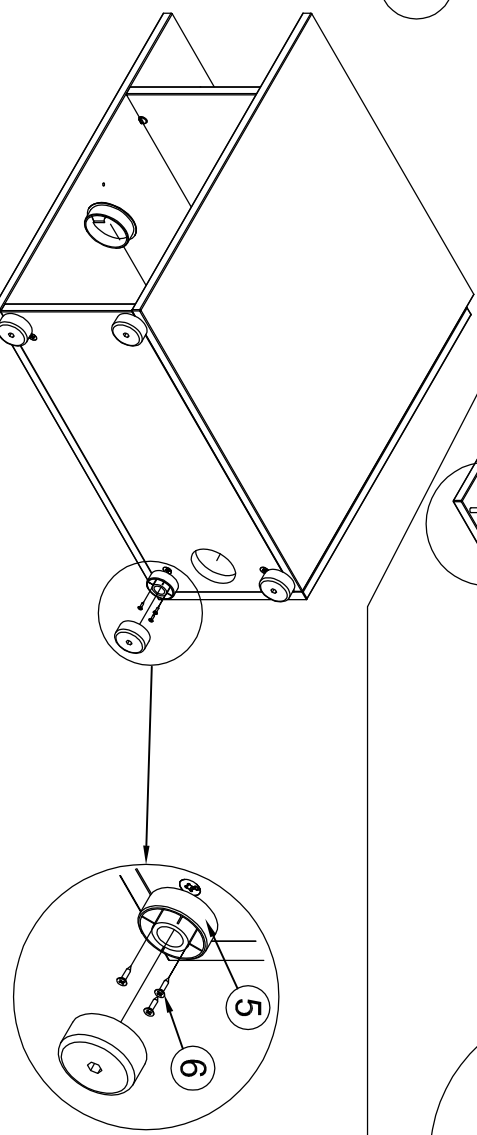



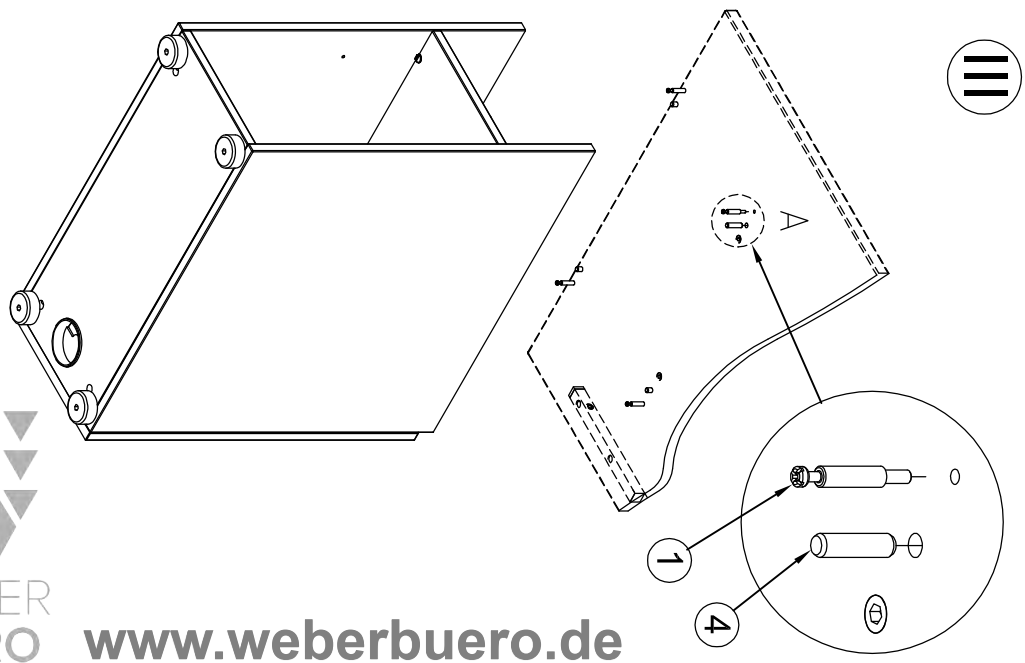



III



M60EB008





1/1

Surinkimo schema
Схема сборки
Assembling scheme

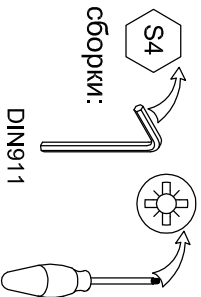
- x2  6
- x6  1
- x2  2
- x2  3
- x2  4
- x4  5

Reikalingi įrankiai:
Инструменты для сборки:
Requiring tools:



- x6  1
- x4  2
- x4  3
- x4  4
- x4  5

DIS161
DIS180

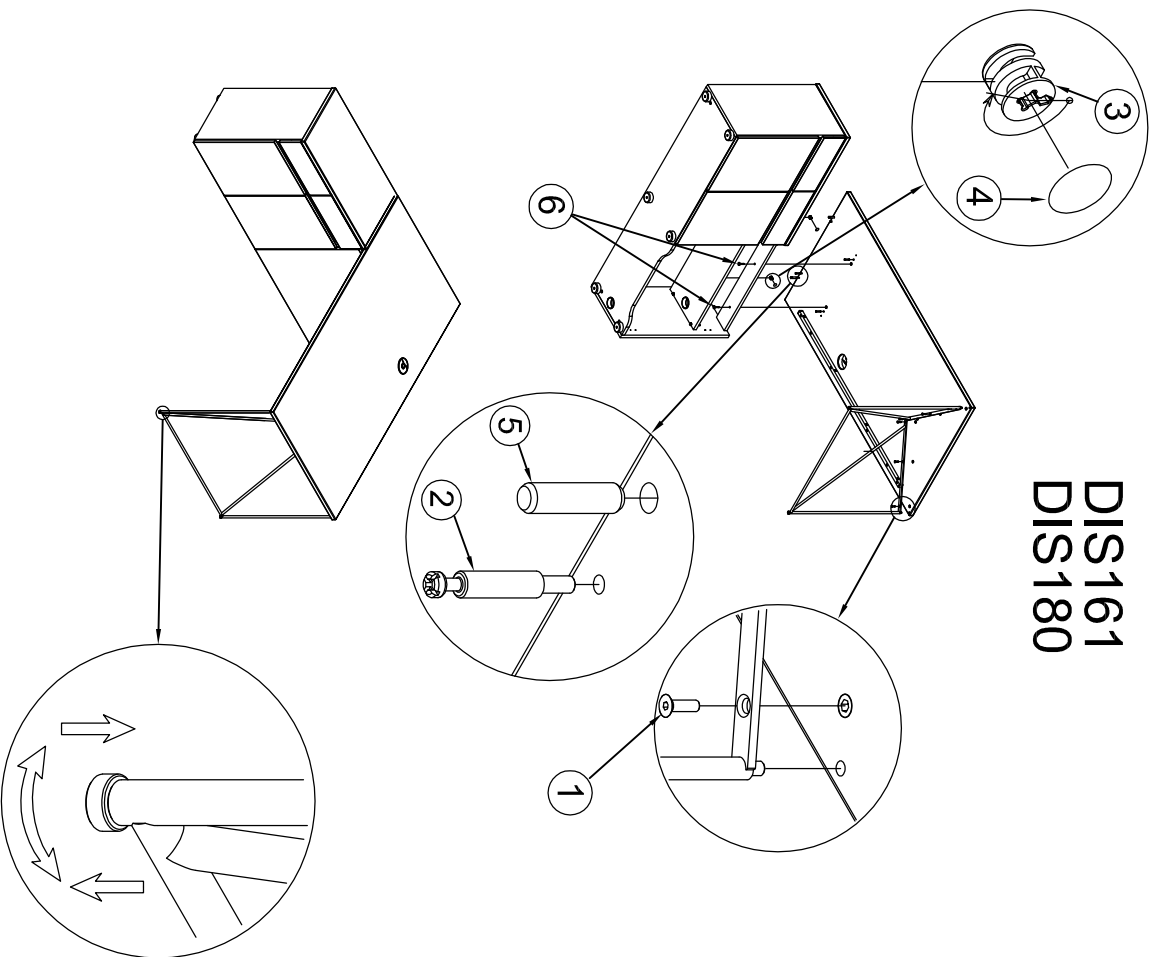

DIA162
DIA182

