

# FILO B1

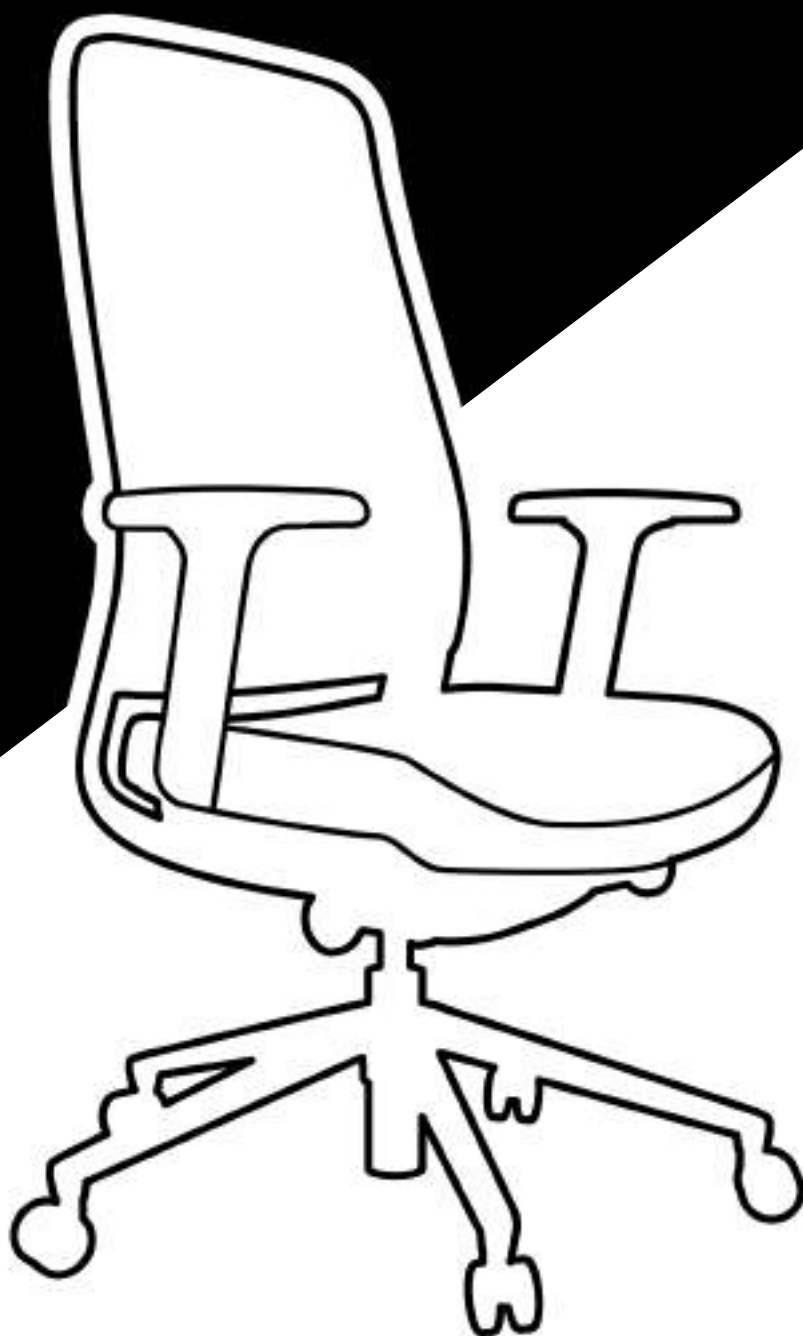



2x



3x



2x

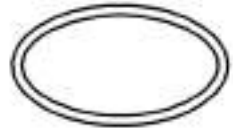

3x



2x



1x

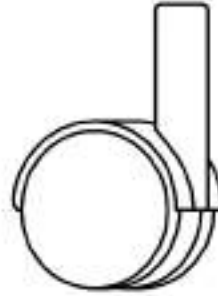

5x

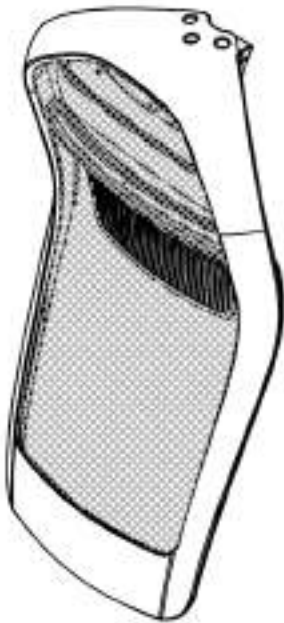

1x



1x

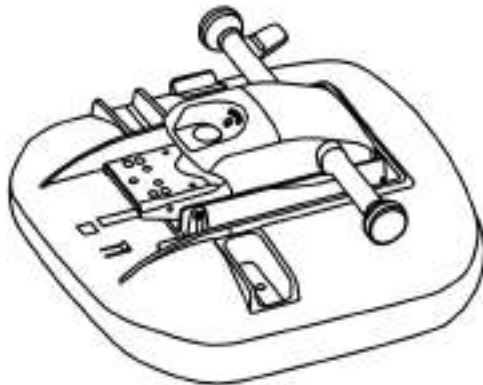

1x



1x



1x

?

SCAN ME

**1**

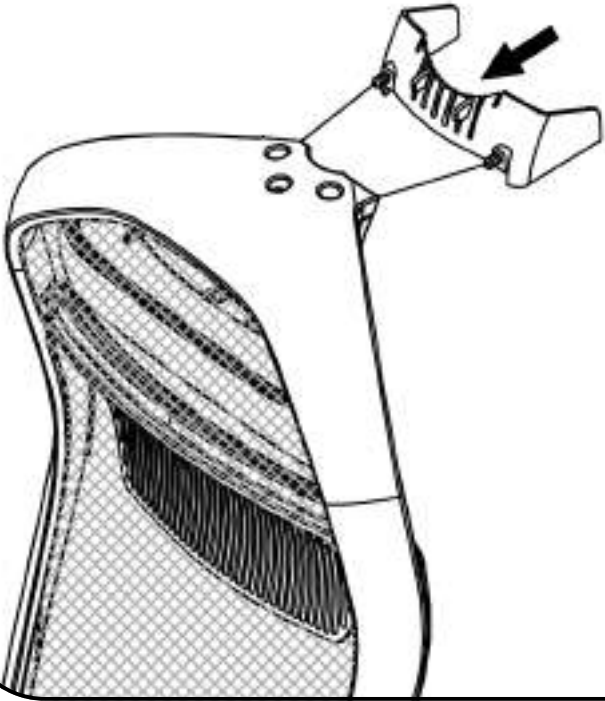

**2**

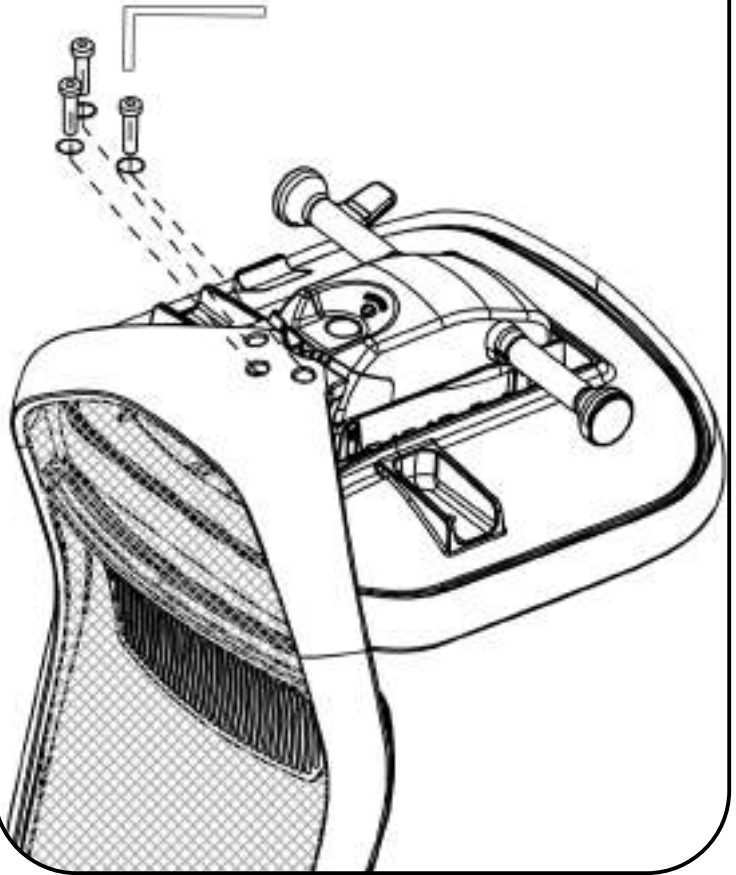

**3**

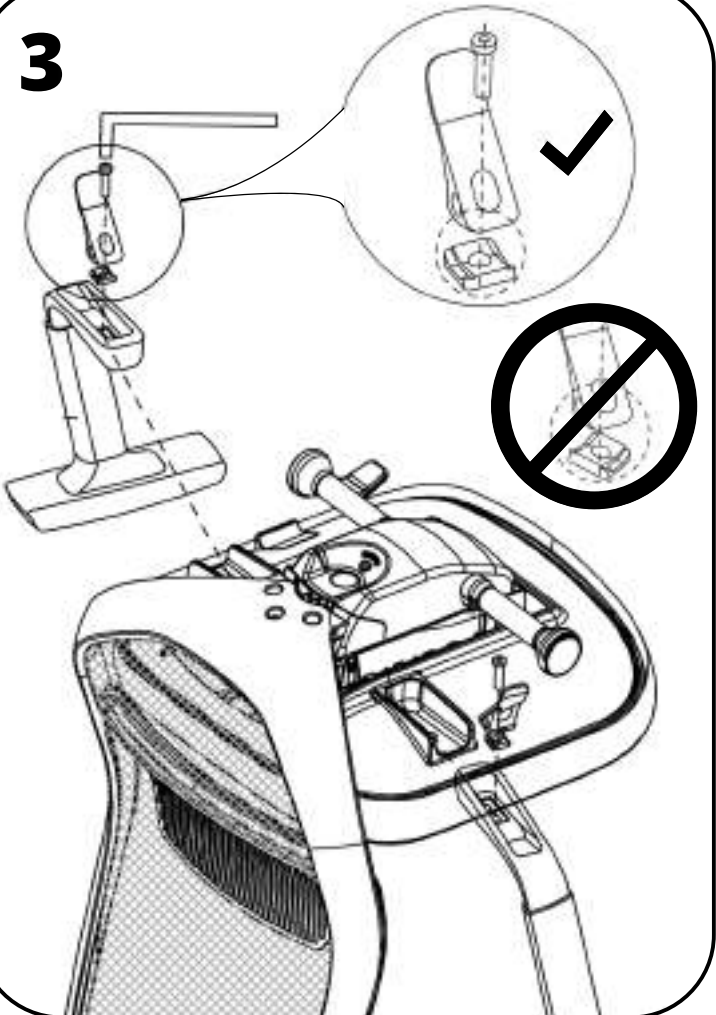

**4**

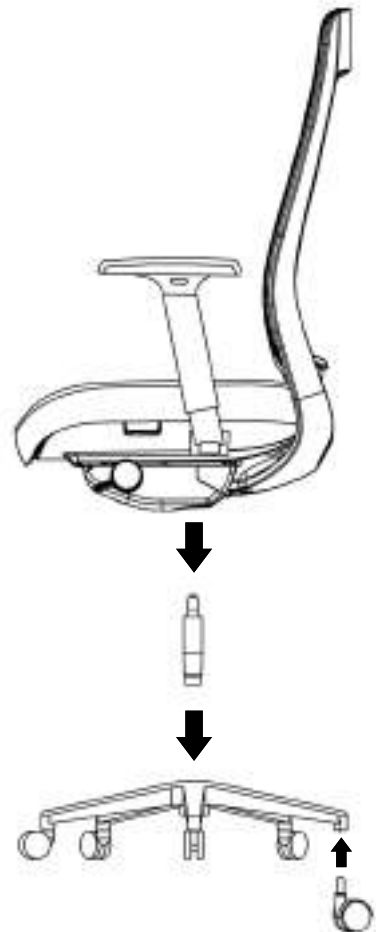



Lordosenstütze  
lumbar support



4D Armlehnen  
4D armrest



Schiebesitz  
seat sliding



Höhenverstellung  
height adjustable



Arretierung der Rückenlehne,  
Einstellung der Synchronmechanik  
tilting lock and tension control